

# H704-42(H)(E), H704-42/1(H)(E)

## Branch Current Monitor

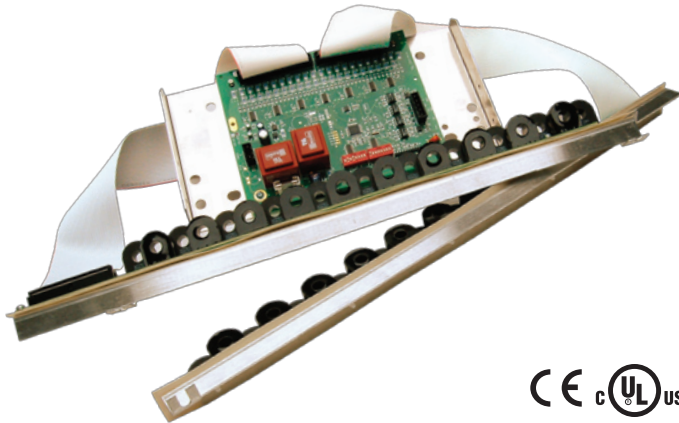

### DANGER

#### HAZARD OF ELECTRIC SHOCK, EXPLOSION, OR ARC FLASH

- Follow safe electrical work practices. See NFPA 70E in the USA, or applicable local codes.
- This equipment must only be installed and serviced by qualified electrical personnel.
- Read, understand and follow the instructions before installing this product.
- Turn off all power supplying equipment before working on or inside the equipment.
- Use a properly rated voltage sensing device to confirm power is off.  
DO NOT DEPEND ON THIS PRODUCT FOR VOLTAGE INDICATION
- Only install this product on insulated conductors.

Failure to follow these instructions will result in death or serious injury.

### NOTICE

- This product is not intended for life or safety applications.
- Do not install this product in hazardous or classified locations.
- The installer is responsible for conformance to all applicable codes.

#### FCC PART 15 INFORMATION

NOTE: This equipment has been tested by the manufacturer and found to comply with the limits for a class A digital device, pursuant to part 15 of the FCC Rules. These limits are designed to provide reasonable protection against harmful interference when the equipment is operated in a commercial environment. This equipment generates, uses, and can radiate radio frequency energy and, if not installed and used in accordance with the instruction manual, may cause harmful interference to radio communications. Operation of this equipment in a residential area is likely to cause harmful interference in which case the user will be required to correct the interference at his own expense. Modifications to this product without the express authorization of Veris Industries nullify this statement.

MODEL #	CT SPACING
H704-42(H)(E)	¾" on center
H704-42/1(H)(E)	1" on center

For a 400A Panel, order the H704-42Y55

#### Installer's Specifications

##### General:

Operating Temp. Range	0° to 60°C (32° to 140°F) (<95% RH, non-condensing)
Storage Temp. Range	-40° to 70°C (-40° to 158°F)
Control (Mains) Power Source	120 VAC L-N, 50/60 Hz (208/230 VAC for H704-42/1(E)) (+10/-25%) Input current < 75 mA
Primary Fusing	250 VAC/100 mA, (T) 5 x 20 mm, (if equipped) Littelfuse 218 series or equivalent
Altitude of Operation	3 km max.

##### Measured Current Inputs:

Number of Channels	42
Frequency	50/60 Hz
Sample Frequency	1280 Hz
Update Rate	1.2 sec
Accuracy	±2% from 5 A to 50 A *
Overload Capability	Tested to 10,000 A single-cycle
Connection to Conductor	Solid-core toroid
Measured Currents	Current range 0-50 A (max. conductor size is AWG#6 THHN)
Measured Currents, H version	Current range 0-100 A (max. conductor size is AWG#2 THHN)

##### Network Communications:

Type	Modbus RTU
Connection	DIP switch-selectable 2-wire or 4-wire
Address	DIP switch-selectable address 1 to 247
Baud Rate	DIP switch-selectable 2400, 4800, 9600, 19200
Parity	DIP switch-selectable NONE, ODD, EVEN
Communication Format	8-data-bits, 1-start-bit, 1-stop-bit
Termination	5-position depluggable connector (TX+ TX- SHIELD TX+/RX+ TX-/RX-)

##### Defaults:

Warning Register	60% of current sensor max. (configurable)
Alarm Register	70% of current sensor max. (configurable)
Breaker Size Register	20 A

\* In case of a current fault above 60A (120 for the H version), all adjacent channels will report higher than actual readings. To prevent this from causing over-current warnings and alarms, configure the warning and alarm delays for a longer time period than the response time of the breaker.

### QUICK INSTALL

1. Disconnect and lock out power.
2. Mount current sensor strips adjacent to breaker terminations.
3. Verify that serial numbers on CT and board match.
4. Mount board onto electrical/fire enclosure.
5. Connect CTs and wire the board.
6. Reconnect power.
7. Configure communication and addressing parameters.

Note: Data acquisition board and CT strips are calibrated as a set. Match the serial numbered parts together.

**OPERATION**

The H704-42 Branch Current Monitor is a current sensing device designed to monitor all 42 poles of a panel board. Designed for critical load monitoring such as Co-location Data Centers and lighting panels, the H704-42 provides important branch circuit amperage and capacity information. By reporting current levels and initiating capacity warnings and alarms, the H704-42 allows the management of power and eliminates open circuits caused by overloaded breakers.

The H704-42 consists of a Data Acquisition Board and two 21-unit current sensor strips. The strips are mounted on each side of the panel board along the termination points of each breaker. The conductor passes through the appropriate current sensor before terminating at the breaker. Each strip transmits the current data to the Data Acquisition Board through snap on ribbon cable. An optional hardware kit is available for mounting the H704-42.

Data is transmitted using an RS485 Modbus protocol. Each Data Acquisition Board is addressed on the modbus daisy chain network.

Setup is made easy with a PC based configuration tool which allows for global or individual selection of breaker size, warning levels, and alarm levels.

*\*For 208/230VAC Power Connection version, order H704-42(H)(E)/H704-42/1(H)(E)*

**DIMENSIONS**

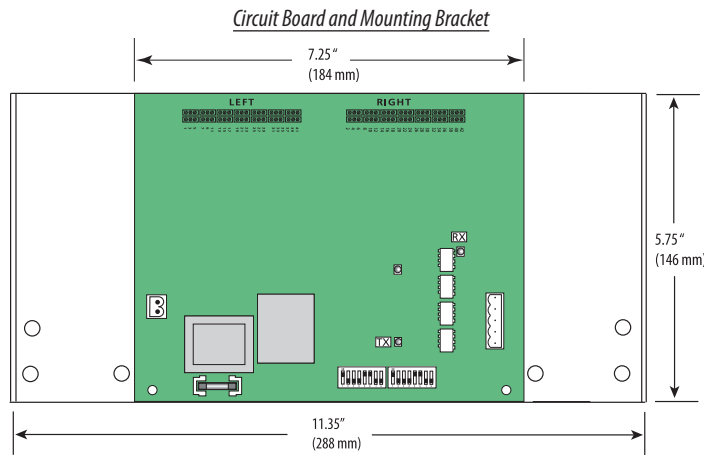

**PRODUCT DIAGRAM**

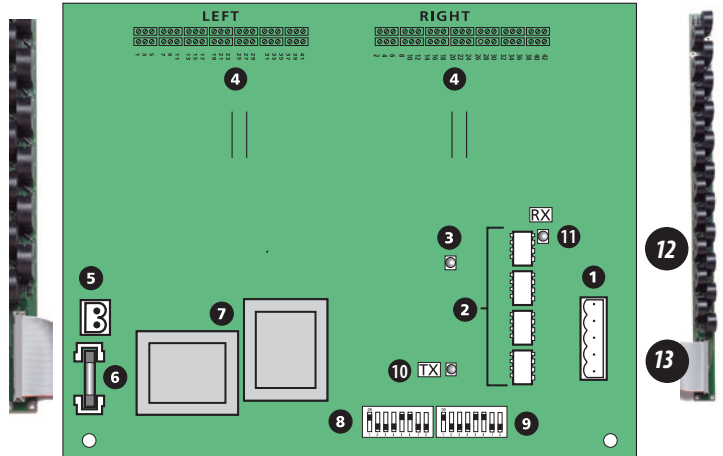

1. **RS 485 2 or 4-Wire Connection:** Daisy chain multiple H704-42's using a 2-wire or 4-wire modbus network.
2. **Optical Communications Isolation:** Optical isolators are used to separate 120 VAC portions of the circuit from the RS485 network.
3. **Alive LED:** Flashes once per second to indicate correct operation. If steadily lit or out, indicates internal failure.
4. **50-Pin Ribbon Cable Connectors (Data Acquisition Board):** 18-inch (457 mm) ribbon cables are provided standard\*\* for easy snap connection of current sensor strips to this point of the Data Acquisition Board.
5. **Control (Mains) Power Connection\*:** Easy 2-wire 120 VAC line to neutral 50/60 Hz.
6. **250VAC 100mA Time Delay Fuse:** Fused power connection for circuit protection.
7. **Power Transformers:** Linear power supply for reliability and low noise
8. **Baud Rate & Parity Selection Switches:** Field selectable RS-485 serial interface control.
9. **Modbus Address Dip Switches:** Each Modbus device must have a unique address. These switches must be set to assign an individual address before the device is connected to the network.
10. **TX LED:** Indicates successful transmission of information over the Modbus network.
11. **RX LED:** Indicates data received on the Modbus network
12. **Current Sensors:** Each current sensor is capable of monitoring conductors carrying up to a maximum of 50 amps. Maximum wire size capacity is #6 AWG THHN. H version can monitor up to 100 amps with a maximum wire size capacity of #2 AWG THHN
13. **50 Pin Ribbon Cable Connectors (CT Strips):** 18" ribbon cables are provided standard\*\* for easy snap connection of Data Acquisition Board strips to this point of the current sensor strips

*\*For 208/230VAC Power Connection version, order catalog number H704-42/H704-42/1E.*

*\*\*Additional sizes are available for sale.*

**SAFETY**

UL listed under standard 508 as an "open type device."  
Installation category: CAT II or CAT III  
Critical components evaluated to UL 1950.

The H704 Series must be installed in as appropriate electrical and fire enclosure per local regulations.

For use in a Pollution Degree 2 or better environment only.

A Pollution Degree 2 environment must control conductive pollution and the possibility of condensation or high humidity. Consideration must be given to the enclosure, the correct use of ventilation, thermal properties of the equipment and the relationship with the environment.



This symbol indicates an electrical shock hazard exists.



Documentation must be consulted where this symbol is used on the product.

**INSTALLATION**

1. Inspect the Mounting Bracket Kit. The acquisition and interconnection boards are mounted to the bracket at the factory.

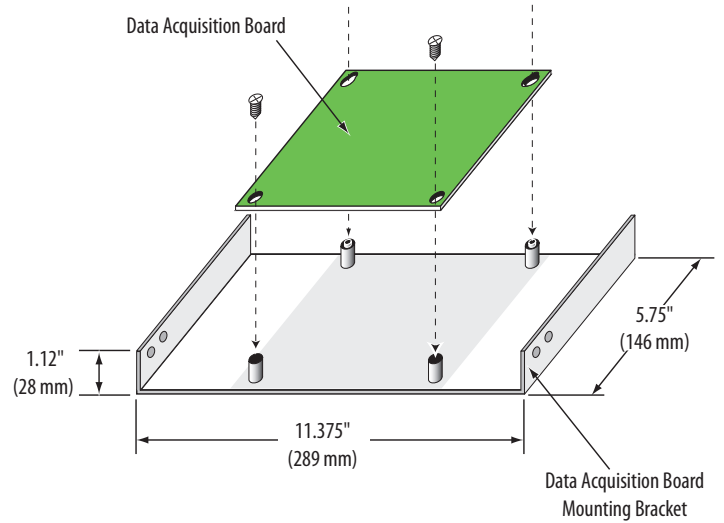

**50A Solid-Core CT Strips**

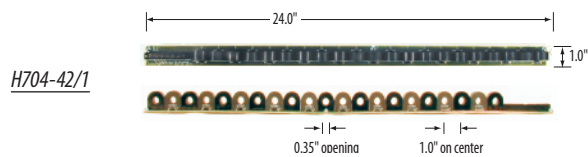
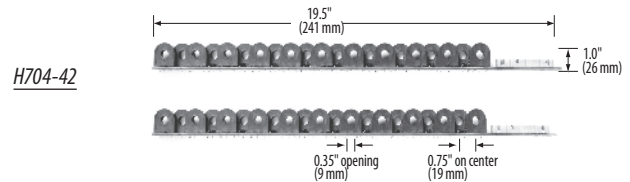

**100A Solid-Core CT Strip**

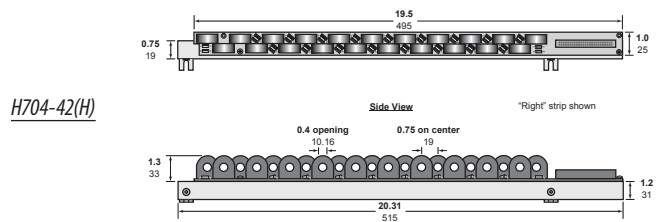

**INSTALLATION, CONT.**

2.  Disconnect power to the electrical panel and lock it out. Connect 2-wire 120 VAC\* power to power terminals. (see Product Diagram for location) Observe polarity.
3. **Current Sensor Strip Installation:** Locate panel board screws which are 16.50" (420 mm) apart and allow the current sensors to line up directly with breaker terminations. Loosen these two screws sufficiently for the brackets (1 & 2) to slip under screws. Do not remove screws completely. Slide the current sensor strip mounting bracket under these loosened screws. Be sure to face the inside of the bracket toward the breakers. Tighten screws. Repeat for the other side of the panel board.
4. Check that CT serial numbers and meter serial numbers match. Meter and CT sold as set with accuracy calibrated as a set.
5. **Acquisition Board Installation:** Find screw holes under panel board in side of PDU chassis or panel. Attach Data Acquisition Board bracket using screws and bolts provided.
6. Pass power wiring through appropriate CT's observing local code for bending radius. Current sensors accommodate for #6 THNN sized conductor. (max. diameter 0.35"/9 mm). Use insulated wire only.

\* For 208/230VAC Power Connection version, order H704-42E/H704-42/IE

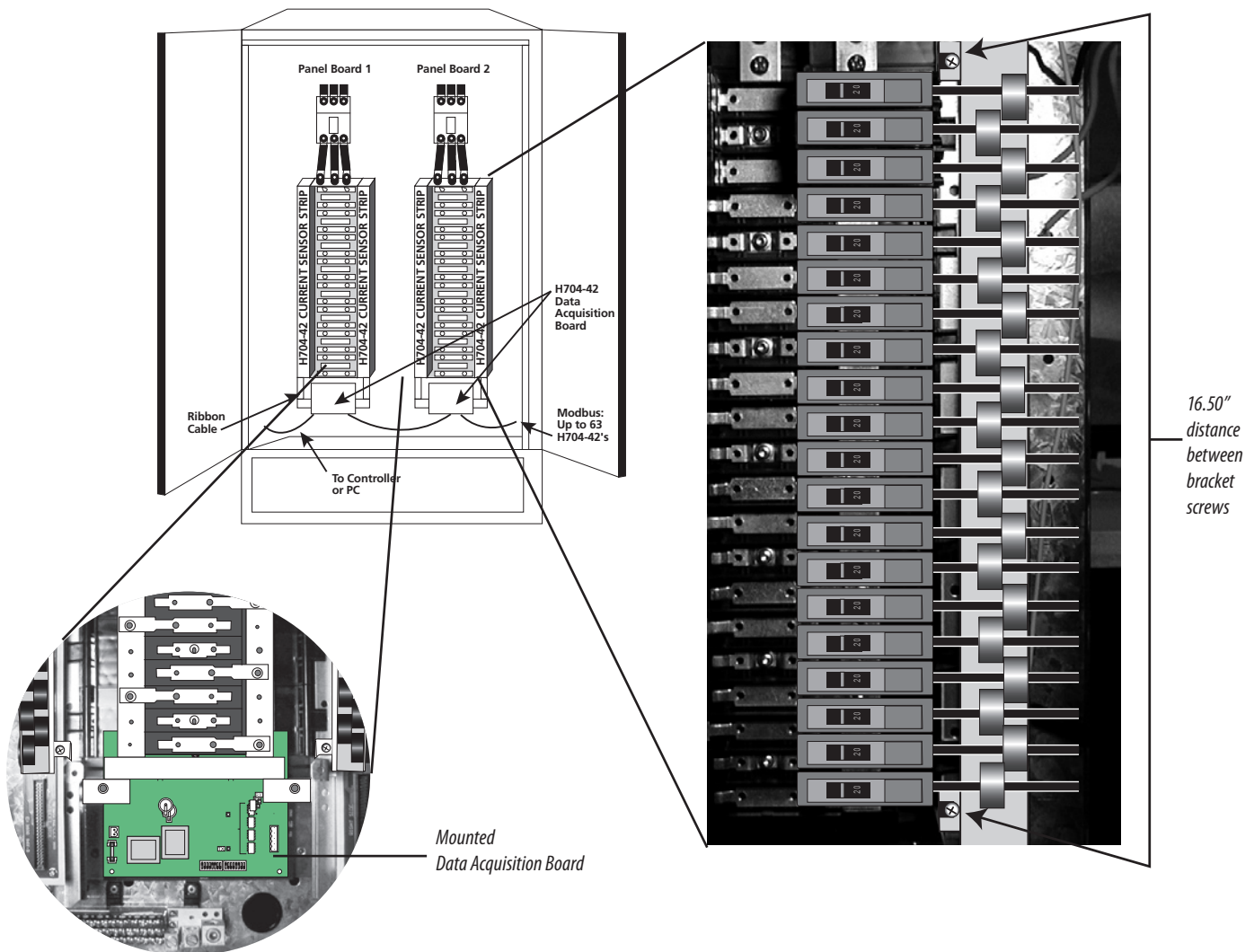

**WIRING**

*Power must be disconnected and locked out before making any wiring connections.*

1. Connect 2-wire or 4-wire Modbus RS485 daisy chain network.

2-Wire

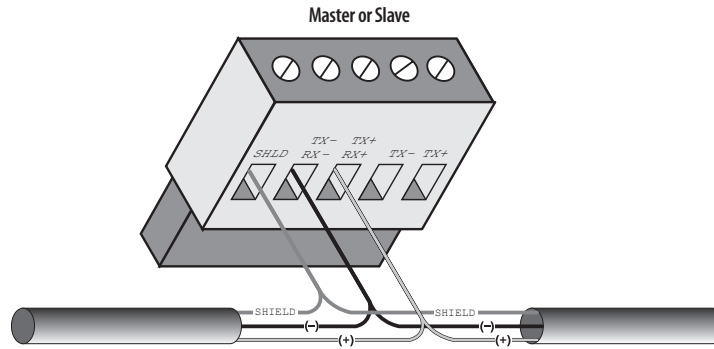

4-Wire

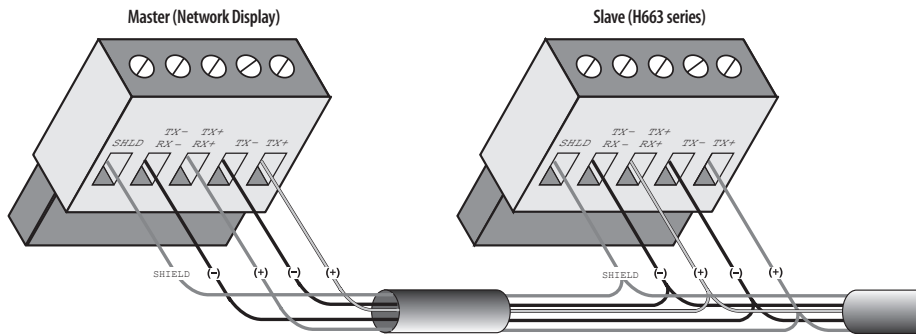

**NOTES**

- A. The Modbus cable should be mechanically secured where it enters the electrical panel.
- B. All Modbus devices should be connected together in a daisy-chain fashion, and properly terminated.
- C. The Modbus cable should be shielded twisted pair wire such as Belden 1120A. The cable must be voltage rated for the installation.



**WARNING:** After wiring the Modbus cable, remove all scraps of wire or foil shield from the electrical panel. This could be DANGEROUS if wire scraps come into contact with high voltage conductors!

2. Use the Software Configuration Tool to set up breaker size, warning levels, and alarm levels. This tool is available online at <http://www.veris.com/modbus.asp>
3. Reconnect power.



Disconnect and lock out power source before making any connections. Connect 2-wire 120 VAC power to power terminals. See Product Diagram section for location. **Observe polarity.**

**CONFIGURATION**

1. **Communications Configuration:** Communications parameters for the H704 series are field selectable for your convenience. Please see Product Diagram section for selector location. The following parameters are configurable:

- Parity On or Off
- Parity: Odd or even
- Wiring: Two or four
- Baud Rate: 2400, 4800, 9600 or 19200

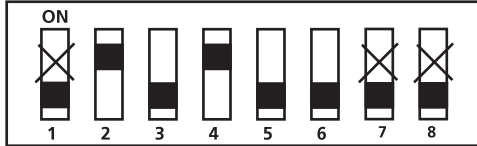

Example: 2-wire 9600 Baud No Parity (Default Only)

2. **Address Configuration:** Each Modbus device on a single network must have a unique address. The switch block must be set to assign a unique address before the device is connected to the Modbus RS485 network. If an address is selected which conflicts with another device, neither device will be able to communicate.

H704 series can be addressed as any whole number between and including 1-247. Each unit is equipped with a set of 8 dip switches for addressing. See below.

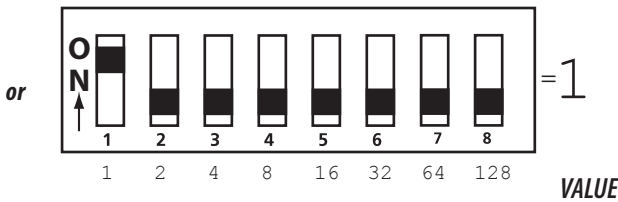
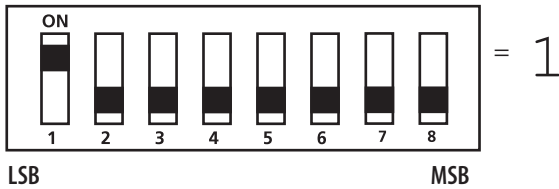

Baud Rate and Parity Switch Settings

Switch #								Wiring, Baud Rate, Parity		
1	2	3	4	5	6	7	8	Wiring	DESIRED RESULT Baud Rate	Parity
X	On					X	X	2 wire		
X	Off					X	X	4 wire		
X		Off	Off			X	X		2400 Baud	
X		On	Off			X	X		4800 Baud	
X		Off	On			X	X		9600 Baud	
X		On	On			X	X		19200 Baud	
				Off	Off					None
				On	Off					Even
				Off	On					Odd

The values of each dip switch are as follows:

- 1=1
- 2=2
- 3=4
- 4=8
- 5=16
- 6=32
- 7=64
- 8=128

To determine an address you simply add the values of any switch that is on.

For example:

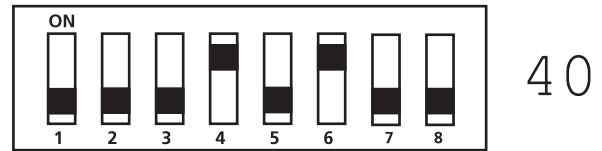

Switch number 4 has an ON Value of 8 and switch number 6 has an ON Value of 32. (8+32 = 40)

See the Communications Setup section for a pictorial listing of the first 63 switch positions.

**COMMUNICATIONS SETUP**

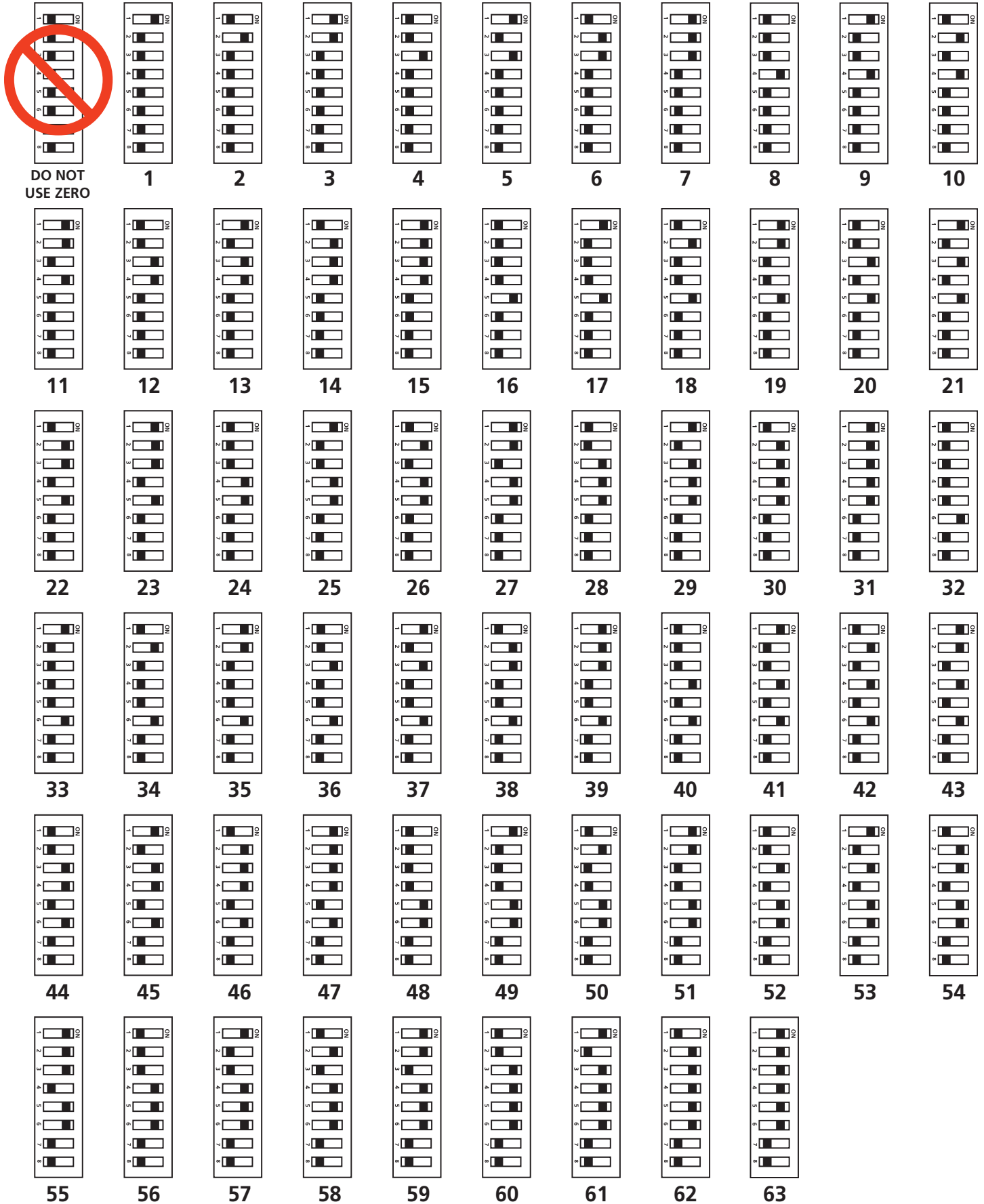

DO NOT USE ZERO

1 2 3 4 5 6 7 8

11 12 13 14 15 16 17 18 19 20 21

22 23 24 25 26 27 28 29 30 31 32

33 34 35 36 37 38 39 40 41 42 43

44 45 46 47 48 49 50 51 52 53 54

55 56 57 58 59 60 61 62 63

## **SERVICE**

### ***Changing the Fuse***

1. Disconnect and lock out power to panel.
2. Disconnect and lock out 120V Control (Mains) Power Source to Data Acquisition Board.
3. Remove old fuse.
4. Replace with new fuse, Littelfuse 218 series or equivalent.
5. Reconnect 120V to Data Acquisition Board.
6. Reconnect power to panel.
7. Check "Alive" LED for proper function (See Product Diagram section for location).

## **ACCESSORIES**

- CBL008 — Cable, Ribbon, 18 in (457 mm), BCM
- CBL016 — Cable, Ribbon, 48 in (1219 mm), BCM
- CBL017 — Cable, Ribbon, 60 in (1524 mm), BCM
- CBL018 — Cable, Ribbon, 72 in (1829 mm), BCM
- CBL019 — Cable, Ribbon, 97 in (2464 mm), BCM
- CBL020 — Cable, Ribbon, 120 in (3048 mm), BCM
- CBL021 — Cable, Ribbon, 240 in (6096 mm), BCM